



ACKERMANN-DIFLEX SYSTEME
ACKERMANN-DIFLEX SYSTEMS

ACKERMANN-DIFLEX SYSTEME | SYSTEMS

ACKERMANN-DIFLEX: FLEXIBLE HALTEARME MIT EINSTELLBARER HALTEKRAFT.

ACKERMANN-DIFLEX: MOBILE FLEXIBLE POSITIONING ARMS WITH ADJUSTABLE RIGIDITY.

Alle Ackermann-Diflex Arme haben eine einzigartige atraumatische Delrin-Klemme welche Endoskope und Instrumente zwischen 3,5 mm und 16 mm sicher hält.

Alle Modelle beinhalten eine OP-Tischklemme für eine schnelle und einfache Montage am OP-Tisch.

All Ackermann-diflex arms feature a unique type atraumatic Delrin clamping tip which securely holds scopes and instruments from 3,5 mm up to 16 mm.

All models feature a self-contained O.R. rail clamp for quick and easy attachment to the operating table.



69-0450

Bookler Laparoskop / Instrumentenhalter,
Bookler laparoscope / Instrument holder

69-0450D

Bookler Laparoskop / Instrumentenhalter, Delrin-Klemme
Bookler laparoscope / Instrument holder, Delrin clamp



69-0500

Bookler Laparoskop / Instrumentenhalter mit Drehverstellung
Bookler laparoscope / Instrument holder with swivel ball positioner

69-0500D

Bookler Laparoskop / Instrumentenhalter mit Drehverstellung, Delrin-Klemme
Bookler laparoscope / Instrument holder with swivel ball positioner, Delrin clamp



ACKERMANN-DIFLEX SYSTEME | SYSTEMS



69-0540

Ackermann-Diflex 1-armiges Flexarm System
Ackermann-diflex Single Flexarm System

69-0540D

Ackermann-Diflex 1-armiges Flexarm System, Delrin-Klemme
Ackermann-diflex Single Flexarm System, Delrin clamp



69-0550

Ackermann-Diflex 2-armiges Flexarm System
Ackermann-diflex twin flexarm system

69-0550D

Ackermann-Diflex 2-armiges Flexarm System, 2 Delrin-Klemmen
Ackermann-diflex twin flexarm system, 2 delrin clamps

69-0550DS

Ackermann-Diflex 2-armiges Flexarm System, Delrin-Klemme und Metall-Klemme
Ackermann-diflex twin flexarm system, delrin tips and s.s. tip

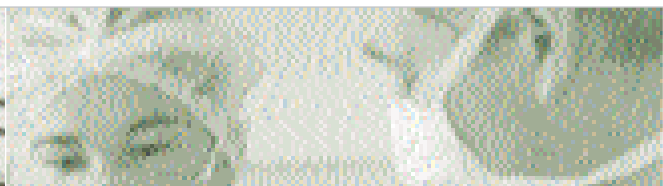

ACKERMANN-DIFLEX SYSTEME, VERLÄNGERTE AUSFÜHRUNG | ACKERMANN-DIFLEX SYSTEMS, LONG REACH



69-0540DLR

Ackermann-Diflex 1-armiges Flexarm System Delrin-Klemme
Ackermann-diflex single flexarm system delrin tip, long reach

69-0540LR

Ackermann-Diflex 1-armiges Flexarm System, Metall-Klemme
Ackermann-diflex single flexarm system s.s. tip, long reach



69-0550SLR

Ackermann-Diflex 2-armiges Flexarm System, Delrin-Klemme und Metall-Klemme
Ackermann-diflex twin flexarm system, delrin tips and 1 s.s. tip

69-0550DLR

Ackermann-Diflex 2-armiges Flexarm System, 2 Delrin-Klemmen
Ackermann-diflex twin flexarm system, 2 delrin tips

69-0550SLR

Ackermann-Diflex 2-armiges Flexarm System, 2 Metall-Klemmen
Ackermann-diflex twin flexarm system, 2 s.s. tips



ACKERMANN-DIFLEX SYSTEME | SYSTEMS

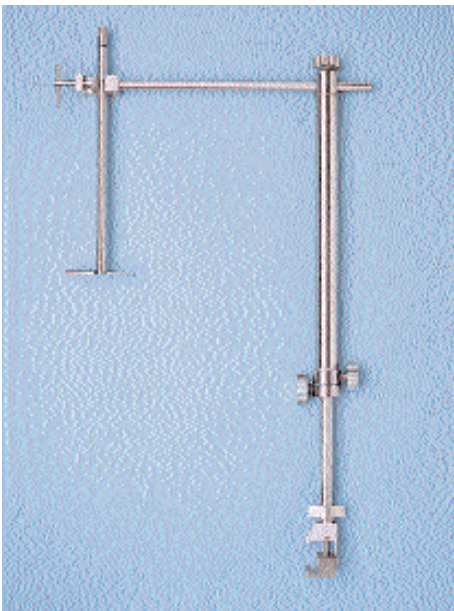

69-0080 Ackermann-Diflex-Bookler A.W.E.L. Bauchdeckenretraktor
Ackermann-diflex-Bookler A.W.E.L. Abdominal Wall Elevator Device

- > Gasloses System entwickelt um die Bauchdecke bei einer laparoskopischen Operation hochzuhalten.
- > Dieses System ermöglicht es mit ganz geringem bis keinem Druck pneumoperitoneale Operationen durchzuführen.
- > *Gasless design to lift and support the abdominal wall during laparoscopic surgery*
- > *allowing for low pressure or no pressure pneumoperitoneal procedures to be performed with maximal exposure.*

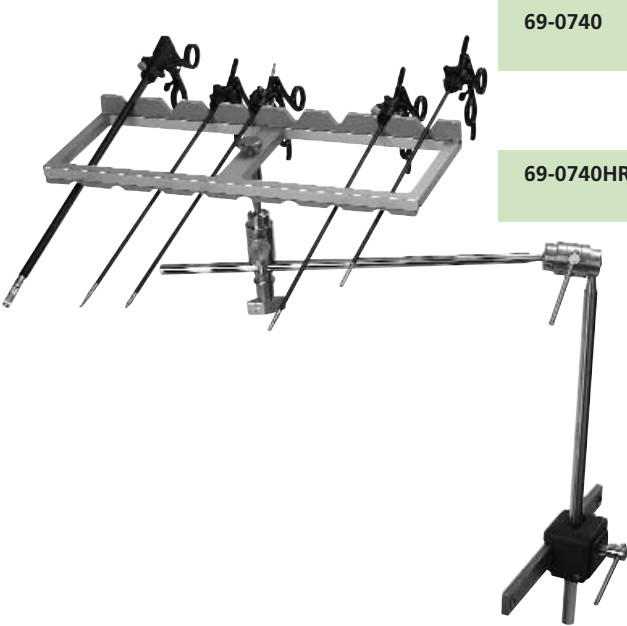

69-0740 Ackermann-Diflex Draughn Lap-Rack
Ackermann-diflex-Draughn lap-rack

69-0740HR Ackermann-Diflex Draughn Half-Rack
Ackermann-diflex-Draughn half-rack

- > Ackermann-Diflex Draughn Universal Lap-Rack erlaubt schnelle und sichere Positionierung von Instrumenten mit Ø 3 mm bis 10 mm.
- > *Ackermann-diflex-Draughn Universal Lap-Rack allows rapid and secure positioning of instruments from Ø 3 mm to 10 mm.*

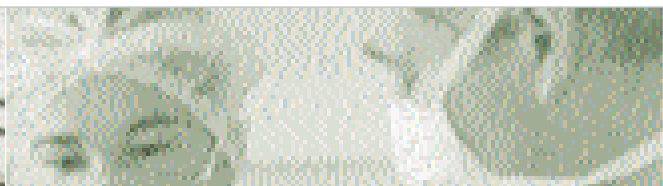

ACKERMANN-DIFLEX SYSTEME | SYSTEMS



69-0600

Gazayerli-Ackermann-Diflex, formbarer Retraktor,
Gazayerli-Ackermann-diflex formable retractor,

Ø 5 mm



69-0610

Gazayerli-Ackermann-Diflex, formbarer Retraktor,
Gazayerli-Ackermann-diflex formable retractor,

Ø 10 mm

> Gazayerli-Ackermann-Diflex formbarer Retraktor für laparoskopische Anwendungen um Organe oder Strukturen wie z.B. der Esophagus, eine vasculares Hilum oder eine peritoneale Ecke zu erreichen.

> *Gazayerli-Ackermann-diflex Formable Retractor used laparoscopically to retract organs or structures such as the esophagus, a vascular hilum or peritoneal edge*

69-0650

Ackermann-Diflex-Pneumatischer Retraktions-Arm
Ackermann-diflex pneumatic retraction arm





ACKERMANN-DIFLEX SYSTEME | SYSTEMS



69-6110

Adler Retractor mit Zubehör
Adler retractor with accessories

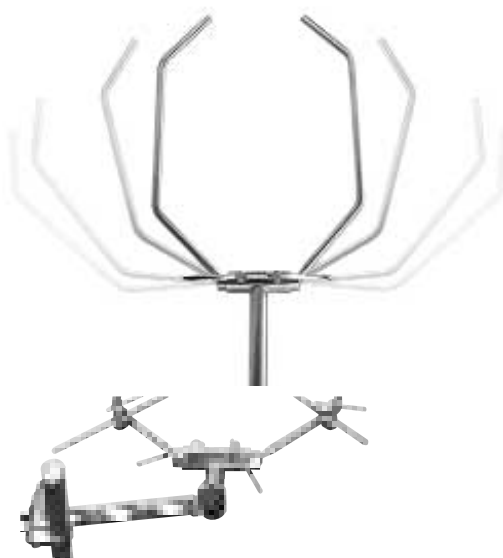

- > Ein neues einzigartiges Retraktor-System zu einem wettbewerbsfähigen Preis und höchst möglicher Qualität. Mit allen Vorteilen die dem Chirurgen eine universelle Anwendung für die offene Chirurgie gewährleistet. Die Valven können kundenspezifisch hergestellt werden um jede Operationsmethode der offenen Chirurgie abzudecken.
- > Dieses Produkt ist für eine Probeanwendung bei einem unserer weltweiten Händler jederzeit verfügbar. Rufen Sie einfach Ihren Ackermann-Händler an.

Inklusive

- > Retraktor-Valven
- > Verstellbarer Wishbone-Ring mit Kugelgelenken
- > Ring-Klemmen um die Valven fest zu klemmen
- > Großes Sortiment von Valven verfügbar, sowie auch jede weitere kundenspezifische Variante
- > OP-Tisch-Klemme

- > *A new unique, retractor system competitively priced, of highest possible quality, all features allowing the surgeon an universal approach also in open surgical procedures, blades can be custom made to each and every requirement in OPEN-surgical procedures.*
- > *This device is available on a trial bases throughout our worldwide distributors.*

Call for your trial or call of any Ackermann distributors.

Including

- > Retractor blades
- > Wishbone adjustable ring with ball joints
- > Ring clamps to clamp the retractor blades
- > Wide array of blades available as well as custom specified blades can be made
- > OR rail clamp universal

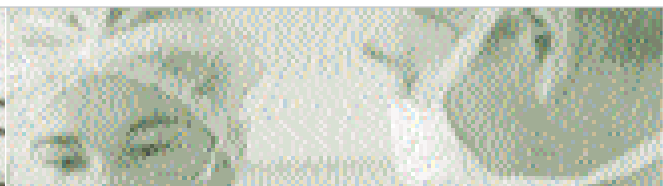

ACKERMANN-DIFLEX SYSTEME | SYSTEMS

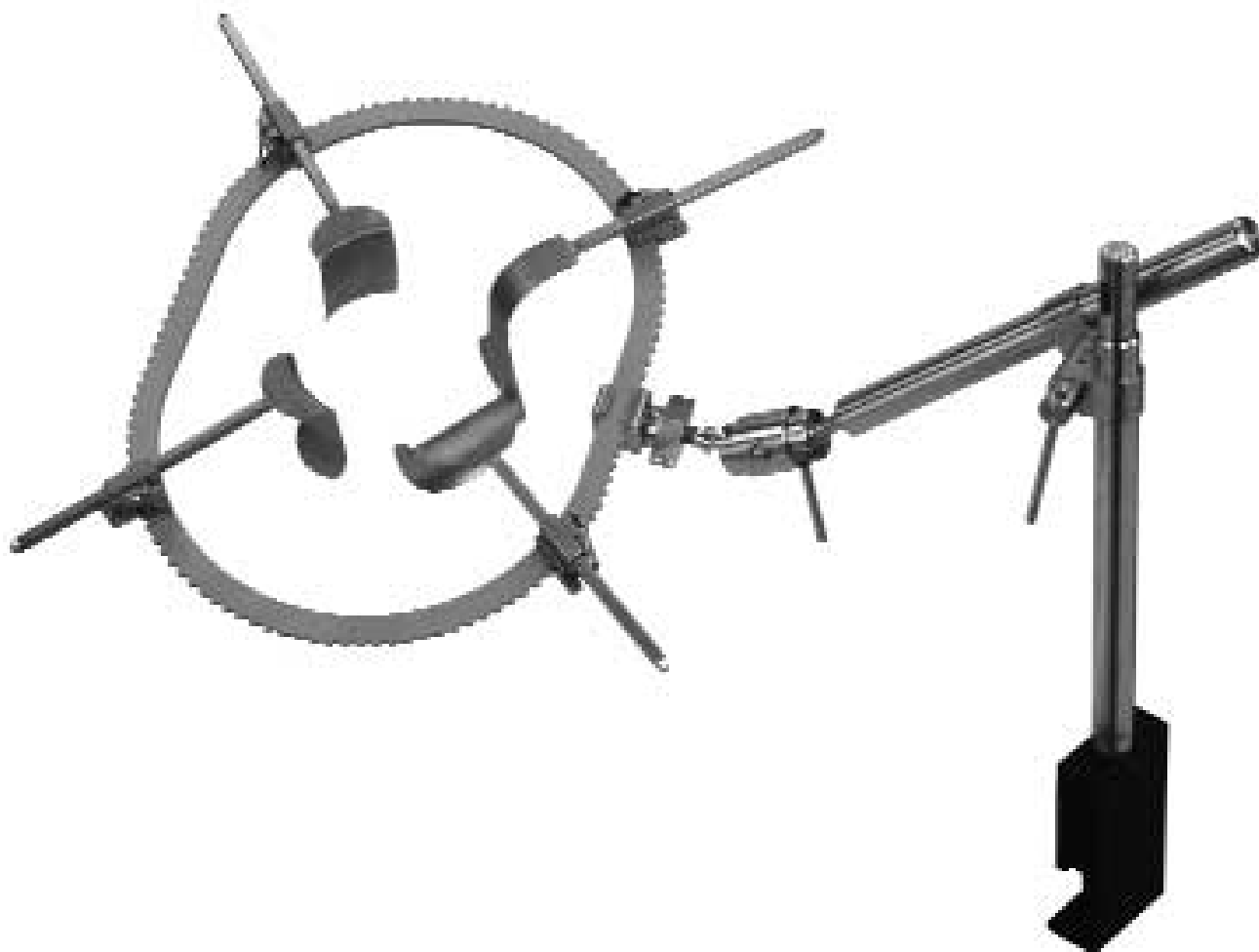

69-0340

Walter Universal Retraktor Komplettsystem
 Walter universal retractor, complete system

Der **Walter Retraktor** kann sehr effektiv für viele Chirurgische Applikationen verwendet werden.

Er hat eine einfache Ständer Montage, eine große Auswahl von verschiedenen Ringen, sehr viele Retraktor Blatt Optionen, eine schnellverriegelung der Blätter, eine Sperrfunktion zur einfachen Justierung, zusätzlich eine horizontale Verlängerung, und eine weitere Kugelgelenksverlängerung dies um flexibler zu sein. Dies erhöht die Verwendungsfähigkeit für viele Applikationen, z. B. Colezystektomie, Peritoneale Resektionen, Nephrektomie, Abdominale Aneurismen, Iliac Femoral Graft Chirurgie, Abdominale Hysterektomie, Appendektomie, Hernia Reparaturen, und nicht zuletzt für die Transplantationschirurgie.

The **Walter Retractor** can be used effectively for many procedures.

Single post fixation, choice of ring configuration, retractor blade options, quick release ratchet mechanism and choice of horizontal bar or horizontal flex bar combine to afford optimal exposure important in many procedures, including cholecystectomy, retroperitoneal resections, nephrectomy, abdominal aortic aneurysms, iliac femoral grafts, abdominal hysterectomy, appendectomy, hernia repair and transplant procedures.



ACKERMANN-DIFLEX SYSTEME | SYSTEMS



69-0340XL

Walter Universal Retraktor Komplettsystem, Großes Set
Walter universal retractor, complete system, extended set

ACKERMANN-DIFLEX SYSTEME | SYSTEMS



69-0360	Flexibler runder und formbarer laparoskopischer Retraktor <i>Flexible laparoscopic round shape, formable retractor</i>	Ø 5 mm
69-0370	Flexibler runder und formbarer laparoskopischer Retraktor <i>Flexible laparoscopic round shape, formable retractor</i>	Ø 10 mm

ERSATZARME | SPARE ARMS



69-0560	Ackermann Flex-Arm mit Metall-Klemme <i>Ackermann flex arm only s.s. tip</i>
----------------	---



69-0560D	Ackermann Flex-Arm mit Delrin-Klemme <i>Ackermann flex arm only delrin tip</i>
-----------------	---



69-3030-AD	Companion Flex-Arm mit Delrin-Klemme <i>Companion flex arm with delrin tip</i>
-------------------	---



69-3030-AS	Companion Flex-Arm mit rostfreier Spitze <i>Companion flex arm with stainless tip</i>
-------------------	--



ACKERMANN-DIFLEX SYSTEME | SYSTEMS

69-0970-FR

Lap-Rack Verriegelung und Rack, ohne Standfuß
Lap-rack mount and full rack only

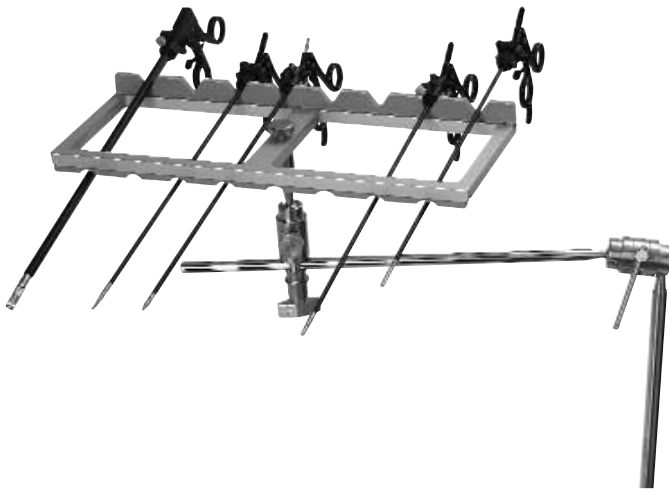

69-0980

Kugelgelenk
Swivel ball assembly

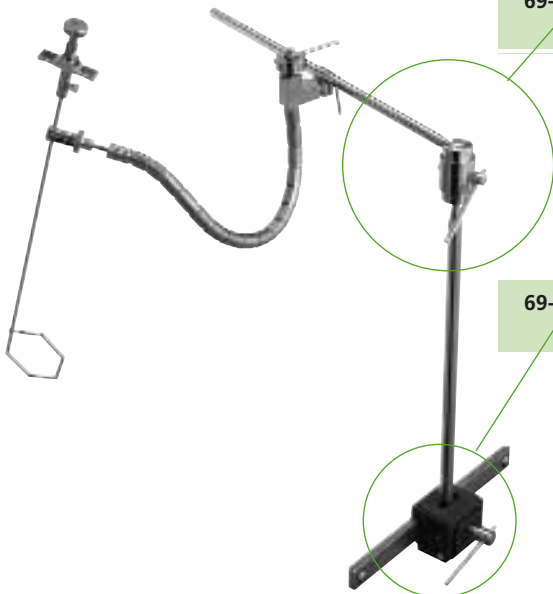

69-0990

OP-Tisch Klemme
OR rail clamp

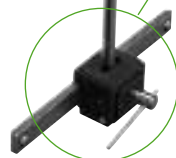

69-1000

Für Bookler Laparoskop Halter mit Drehverstellung die 600 mm lange Querstange starr
For the bookler laparoscope holder the solid stainless rod 600 mm long



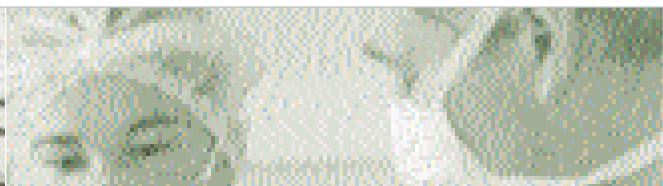

ACKERMANN-DIFLEX SYSTEME | SYSTEMS

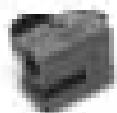

69-1870 Retractor Blade-Klemme, komplett
Retractor blade-clamp, complete



69-1870-A Retractor Blade-Klemme mit Sperre
Retractor blade-clamp with tilt ratchet

69-5140 Vernick-Oetiker-Hepatic Resektions-Klemme, atraumatisch
Vernick-Oetiker-Hepatic resection clamp, atraumatic



69-5450 Standfuß mit Anschluss,
Post coupling assembly, 25 mm

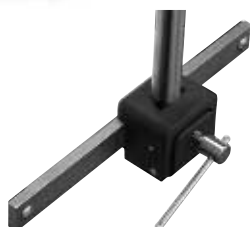

69-5880 Grundfuß mit Anschluss,
Primary post assembly, 25 mm



69-5890 Wisbone Retraktor Arm, komplett
Wishbone retractor frame assembly, complete

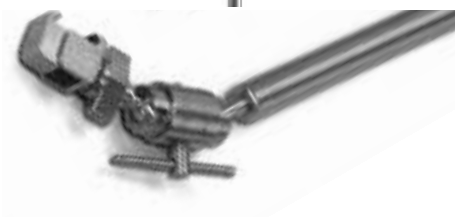

69-5920 Extension Brücke
Extension bridge



RETRAKTOR BLÄTTER FÜR B.WALTER |
 RETRACTOR BLADES FOR B.WALTER



Für Retraktor 69-0340
 For retractor 69-0340



69-6030	Balfour Retraktor Valven, komplett, <i>Balfour retractor blade, complete,</i>	18 mm x 75 mm
69-6040	Harrington Retraktor Valven, komplett <i>Harrington retractor blade, complete</i>	
69-6050	Malleable Retraktor Valven, komplett, <i>Malleable retractor blade, complete,</i>	200 mm x 75 mm
69-6060	Malleable Retraktor Valven, komplett, <i>Malleable retractor blade, complete,</i>	150 mm x 75 mm
69-6070	<i>Kelly Retraktor Valven, komplett,</i> <i>Kelly retractor blade, complete,</i>	50 mm x 75 mm
69-6080	<i>Kelly Retraktor Valven, komplett,</i> <i>Kelly retractor blade, complete,</i>	50 mm x 100 mm
69-7400	Harrington bariatric Valven, komplett <i>Harrington retractor blade, complete</i>	
69-7410	Kelly Bariatric Valven, komplett <i>Kelly bariatric blade, complete</i>	
69-7420	Joe's Hoe Bariatric Valven, komplett, <i>Joe's Hoe bariatric blade, complete</i>	
69-7430	Malleable Bariatric Valven, komplett, <i>Malleable bariatric blade, complete</i>	10 mm
69-7440	Malleable Bariatric Valven, komplett, <i>Malleable bariatric blade, complete</i>	12 mm
69-7450	Deaver Bariatric Valven, komplett, <i>Deaver bariatric blade, complete</i>	7 mm
69-7500	Komplettes Spezial Leber Retraktor System, <i>Complete specialty liver retractor system,</i>	5 mm
69-7520	Komplettes Spezial Leber Retraktor System, <i>Complete specialty liver retractor system,</i>	10 mm

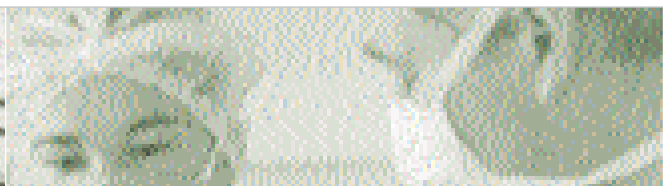

RETRAKTOR BLÄTTER FÜR ADLER RETRACTOR BLADES FOR ADLER



Für Retraktor 69-6110
For retractor 69-6110



69-6030ADL	Balfour Retraktor Valven, komplett, <i>Balfour retractor blade, complete,</i>	18 mm x 75 mm
69-6040ADL	Harrington Retraktor Valven, komplett <i>Harrington retractor blade, complete</i>	
69-6050ADL	Malleable Retraktor Valven, komplett, <i>Malleable retractor blade, complete,</i>	200 mm x 75 mm
69-6060ADL	Malleable Retraktor Valven, komplett, <i>Malleable retractor blade, complete,</i>	150 mm x 75 mm
69-6070ADL	<i>Kelly Retraktor Valven, komplett,</i> <i>Kelly retractor blade, complete,</i>	50 mm x 75 mm
69-6080ADL	<i>Kelly Retraktor Valven, komplett,</i> <i>Kelly retractor blade, complete,</i>	50 mm x 100 mm
69-7400ADL	Harrington bariatric Valven, komplett <i>Harrington retractor blade, complete</i>	
69-7410ADL	Kelly Bariatric Valven, komplett <i>Kelly bariatric blade, complete</i>	
69-7420ADL	Joe's Hoe Bariatric Valven, komplett <i>Joe's Hoe bariatric blade, complete</i>	
69-7430ADL	Malleable Bariatric Valven, komplett, <i>Malleable bariatric blade, complete</i>	10 mm
69-7440ADL	Malleable Bariatric Valven, komplett, <i>Malleable bariatric blade, complete</i>	12 mm
69-7450ADL	Deaver Bariatric Valven, komplett, <i>Deaver bariatric blade, complete</i>	7 mm

ACKERMANN INSTRUMENTE GmbH, GERMANY
Eisenbahnstraße 65-67
78604 Rietheim-Weilheim

Phone: ++49 (0) 74 61 / 9 66 17-0
Fax: ++49 (0) 74 61 / 9 66 17-70

info@ackermanninstrumente.de
www.ackermanninstrumente.de