

NEUROENDOSKOPIE  
*NEUROENDOSCOPY*

## MINI NEURO SET | *MINI NEURO SET*

Kugel Spitze | *Ball tip*

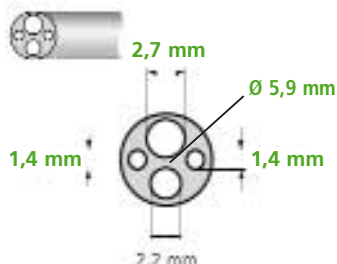

60-7001V | 60-7002V

<b>60-7001</b> <b>60-7001V</b>	Neurochirurgischer Endoskopie Schaft mit 3 Kanälen für 2,7 mm Optiken, <i>Neurosurgical endoscopic sheath with 3 channels for 2,7 mm scope,</i>	187,5 mm
	<b>60-7001V</b> Mit Ventil   <i>With valve</i>	
<b>60-7002</b> <b>60-7002V</b>	Neurochirurgischer Endoskopie Schaft mit 3 Kanälen für 2,7 mm Optiken, <i>Neurosurgical endoscopic sheath with 3 channels for 2,7 mm scope,</i>	302 mm
	<b>60-7002V</b> Mit Ventil   <i>With valve</i>	

## 2,7 MM OPTIKEN | *SCOPES*

Für die Verwendung ohne OP-Schaft und für die Diagnostik | *For use without OP-sheaths and for diagnostics*

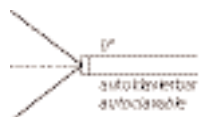

<b>60-7117</b>	Miniatur Endoskop, autoklavierbar, für Neurochirurgie, Okular 90° zum Schaft, <i>Miniature endoscope, autoclavable, for neurosurgery, ocular is 90° to the sheath,</i>	0° 2,7 mm
<b>60-7117G</b>	Miniatur Endoskop wie oben, <b>Gold Version</b> , <i>Miniature endoscope as above, gold version,</i>	0° 2,7 mm
<b>60-7118</b>	Miniatur Endoskop, autoklavierbar, für Neurochirurgie, Okular 90° zum Schaft <i>Miniature endoscope, autoclavable, for neurosurgery, ocular is 90° to the sheath</i>	30° 2,7 mm
<b>60-7118G</b>	Miniatur Endoskop wie oben, <b>Gold Version</b> , <i>Miniature endoscope as above, gold version,</i>	30° 2,7 mm
<b>60-7114</b>	Miniatur Endoskop, autoklavierbar, für Neurochirurgie, Okular 90° zum Schaft, <i>Miniature endoscope, autoclavable, for neurosurgery, ocular is 90° to the sheath,</i>	70° 2,7 mm
<b>60-7114G</b>	Miniatur Endoskop wie oben, <b>Gold Version</b> , <i>Miniature endoscope as above, gold version,</i>	70° 2,7 mm



# MINI NEURO SET | MINI NEURO SET

Für die Verwendung mit den Schäften 60-7001 und 60-7002 | For use with the sheaths 60-7001 and 60-7002

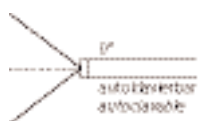
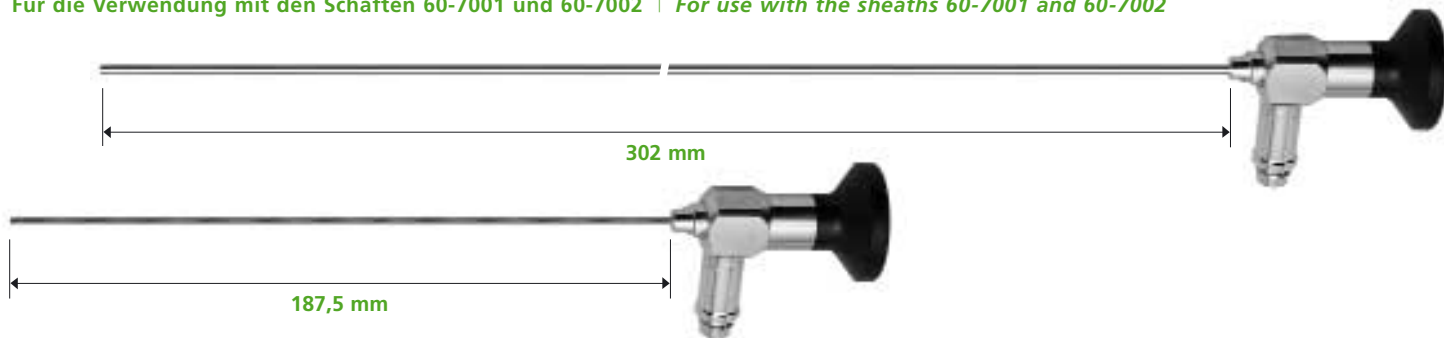

<b>60-7100</b>	Miniatur Endoskop, autoklavierbar, 302 mm, <i>Miniature endoscope, autoclavable, 302 mm,</i>	0° 2,7 mm
<b>60-7100G</b>	Miniatur Endoskop, autoklavierbar, 302 mm, <b>Gold Version,</b> <i>Miniature endoscope, autoclavable, 302 mm, gold version,</i>	0° 2,7 mm

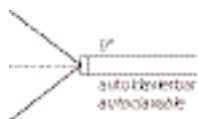

<b>60-7101</b>	Miniatur Endoskop, autoklavierbar, 187,5 mm, <i>Miniature endoscope, autoclavable, 187,5 mm,</i>	0° 2,7 mm
<b>60-7101G</b>	Miniatur Endoskop, autoklavierbar, 187,5 mm, <b>Gold Version,</b> <i>Miniature endoscope, autoclavable, 187,5 mm, gold version,</i>	0° 2,7 mm



<b>60-7105</b>	Miniatur Endoskop, autoklavierbar, 302 mm, <i>Miniature endoscope, autoclavable, 302 mm,</i>	30° 2,7 mm
<b>60-7105G</b>	Miniatur Endoskop, autoklavierbar, 302 mm, <b>Gold Version,</b> <i>Miniature endoscope, autoclavable, 302 mm, gold version,</i>	30° 2,7 mm



<b>60-7106</b>	Miniatur Endoskop, autoklavierbar, 187,5 mm, <i>Miniature endoscope, autoclavable, 187,5 mm,</i>	30° 2,7 mm
<b>60-7106G</b>	Miniatur Endoskop, autoklavierbar, 187,5 mm, <b>Gold Version,</b> <i>Miniature endoscope, autoclavable, 187,5 mm, gold version,</i>	30° 2,7 mm



<b>60-7110</b>	Miniatur Endoskop, autoklavierbar, 187,5 mm, <i>Miniature endoscope, autoclavable, 187,5 mm,</i>	70° 2,7 mm
<b>60-7110G</b>	Miniatur Endoskop, autoklavierbar, 187,5 mm, <b>Gold Version,</b> <i>Miniature endoscope, autoclavable, 187,5 mm, gold version,</i>	70° 2,7 mm

60

## MINI NEURO SET | *MINI NEURO SET*

### KOMBINATIONSGERÄT | *COMBINED UNIT*

Mit Operationskanal in der Optik | *With operating channels inside the scope*

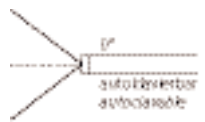
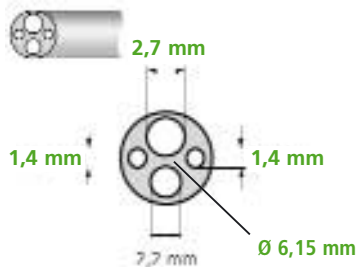

<b>60-7111</b>	Endoskop, autoklavierbar, für Neurochirurgie, 2,5 mm OP-Kanal, 2 x 1,4 mm Saugspülkanal, Endoscope, autoclavable, for neurosurgery, 2,5 mm OP channel, 2 x 1,4 mm suction irrigation,	0°
<b>60-7111G</b>	Miniatur Endoskop wie oben, <b>Gold Version</b> , <i>Miniature endoscope as above, gold version,</i>	0°
<b>60-7112</b>	Endoskop, autoklavierbar, für Neurochirurgie, 2,5 mm OP-Kanal, 2 x 1,4 mm Saugspülkanal, Endoscope, autoclavable, for neurosurgery, 2,5 mm OP channel, 2 x 1,4 mm suction irrigation,	30°
<b>60-7112G</b>	Miniatur Endoskop wie oben, <b>Gold Version</b> , <i>Miniature endoscope as above, gold version,</i>	30°

### ZOOMBARE NEUROSKOPE | *ZOOMABLE NEUROSCOPES*

Direct coupling | *Direct coupling*

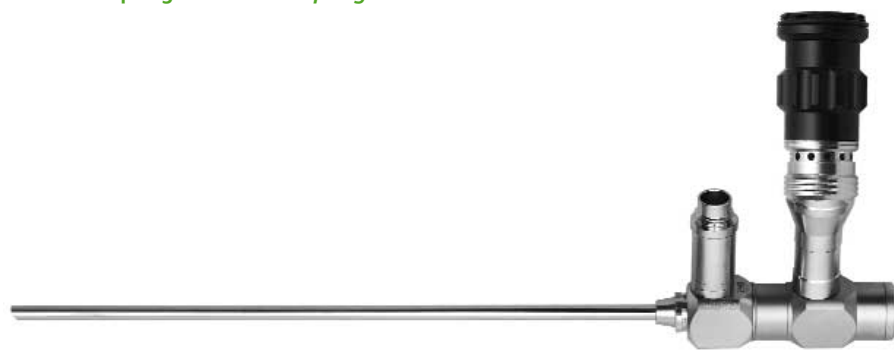

Direktverriegelung mit Adapter 15-1702 DC  
*Direct Coupling with adapter 15-1702 DC*



<b>60-7119</b>	Endoskop, autoklavierbar, für Neurochirurgie, Okular 90° zum Schaft, zoombar, Endoscope, autoclavable, for neurosurgery, ocular is 90° to the sheath, zoom,	30° 5 mm
<b>60-7122</b>	Endoskop, autoklavierbar, für Neurochirurgie, Okular 90° zum Schaft, zoombar, Endoscope, autoclavable, for neurosurgery, ocular is 90° to the sheath, zoom,	30° 10mm



# MINI NEURO SET | MINI NEURO SET

4 MM OPTIKEN | SCOPES

Für die Verwendung ohne OP-Schaft und für die Diagnostik | For use without OP-sheaths and for diagnostics

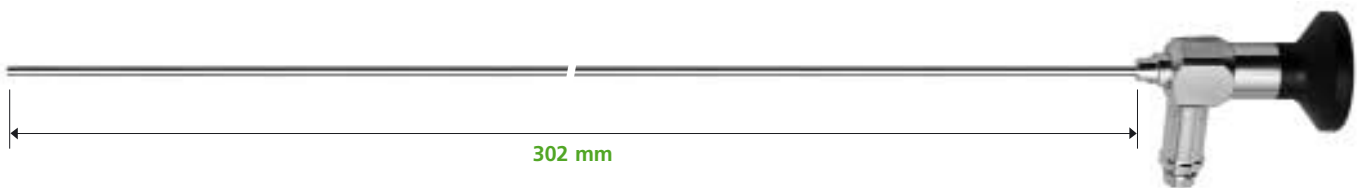

Direktverriegelung mit Adapter 15-1702 DC  
Direct Coupling with adapter 15-1702 DC



<b>60-7115</b>	Miniatur Endoskop, autoklavierbar, 302 mm, Miniature endoscope, autoclavable, 302 mm,	0° 4 mm
<b>60-7120</b>	Miniatur Endoskop, autoklavierbar, 302 mm, Miniature endoscope, autoclavable, 302 mm,	30° 4 mm

## NEUROENDOSKOPIE | NEUROENDOSCOPY

### 4 MM OPTIKEN | SCOPES

Für die Verwendung ohne OP-Schaft und für die Diagnostik | For use without OP-sheaths and for diagnostics



**60-7116**

Miniatur Endoskop, autoklavierbar, 175 mm,  
*Miniature endoscope, autoclavable, 175 mm,*

0°  
4 mm



**60-7121**

Miniatur Endoskop, autoklavierbar, 175 mm,  
*Miniature endoscope, autoclavable, 175 mm,*

30°  
4 mm



**60-7125**

Miniatur Endoskop, autoklavierbar, 175 mm,  
*Miniature endoscope, autoclavable, 175 mm,*

70°  
4 mm



## NEUROENDOSKOPIE | NEUROENDOSCOPY

### NEUROCHIRURGISCHES FLEXIBLES ENDOSKOPE | NEUROSURGICAL FLEXIBLE ENDOSCOPES

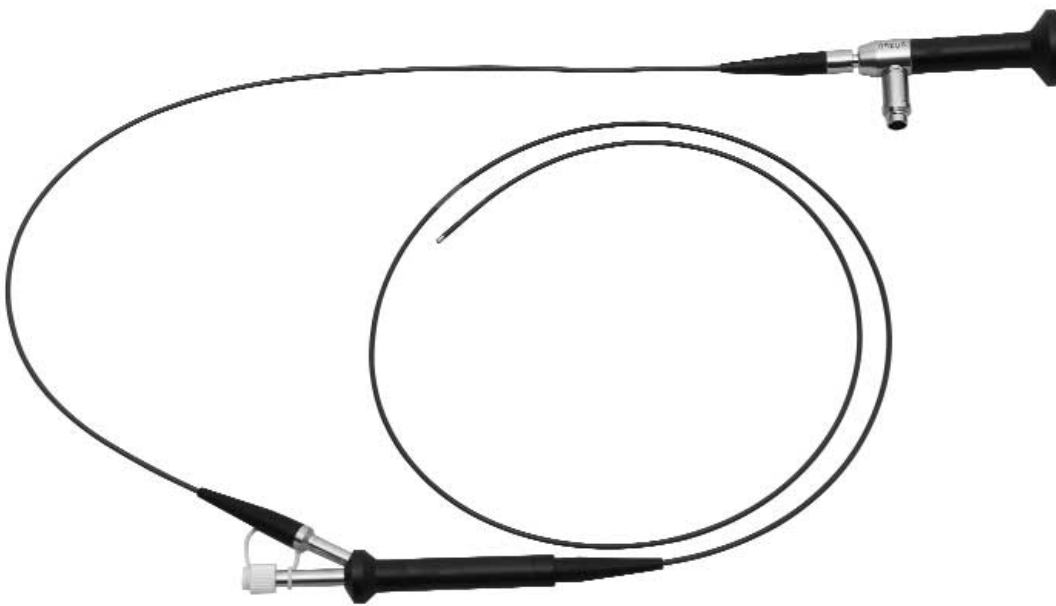

**60-7126**

Außendurchmesser 2,3 mm, Länge 1000 mm, Arbeitskanal 1,1 mm für Laserfaser  
Outer diameter 2,3 mm, length 1000 mm, working channel for laserfibers 1,1 mm



**60-7087**

Außendurchmesser 3,8 mm, Länge 300 mm  
Outer diameter 3,8 mm, length 300 mm

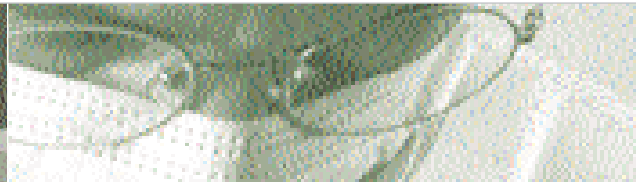







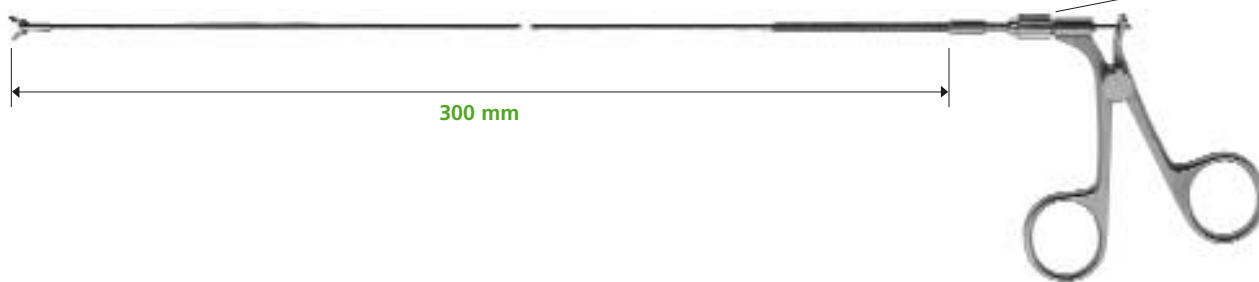

## MINI NEURO SET | *MINI NEURO SET*

STARRER SCHAFT, DREHBAR | *RIGID SHAFTS, ROTATABLE*

Drehbar | *Rotatable*



	<b>60-7000</b>	Alligator Greifzange, 300 mm, drehbar, <i>Alligator forceps, 300 mm, rotatable,</i>	Ø 2,1 mm
	<b>60-7005</b>	Biopsie Greifzange, 300 mm, drehbar, <i>Biopsy forceps, 300 mm, rotatable,</i>	Ø 2,1 mm
	<b>60-7010</b>	Greifzange, 300 mm, drehbar, <i>Grasping forceps, 300 mm, rotatable,</i>	Ø 2,1 mm
	<b>60-7015</b>	Greifzange, 1 x 2 Zähne, 300 mm, drehbar, <i>Rat tooth forceps, 1 x 2 teeth, 300 mm, rotatable,</i>	Ø 2,1 mm
	<b>60-7020</b>	Schere, 300 mm, spitz, drehbar, <i>Scissors, 300 mm, pointed, rotatable,</i>	Ø 2,1 mm
	<b>60-7025</b>	Alligator Greifzange, 300 mm, drehbar, <i>Alligator forceps, 300 mm, rotatable,</i>	Ø 1,2 mm
	<b>60-7030</b>	Biopsie Zange, 300 mm, drehbar, <i>Biopsy forceps, 300 mm, rotatable,</i>	Ø 1,2 mm
	<b>60-7035</b>	Greifzange, 300 mm, drehbar, <i>Grasping forceps, 300 mm, rotatable,</i>	Ø 1,2 mm



# NEUROENDOSKOPIE | NEUROENDOSCOPY

STARRER SCHAFT, DREHBAR | RIGID SHAFTS, ROTATABLE



	<b>60-7040</b>	Greifzange, 1 x 2 Zähne, 300 mm, drehbar, <i>Rat tooth forceps, 1 x 2 teeth, 300 mm, rotatable,</i>	Ø 1,2 mm
	<b>60-7045</b>	Schere, 300 mm, drehbar, <i>Scissors, 300 mm, rotatable,</i>	Ø 1,2 mm
	<b>60-7050</b>	Alligator Greifzange, 300 mm, drehbar, <i>Alligator forceps, 300 mm, rotatable,</i>	Ø 0,9 mm
	<b>60-7055</b>	Biopsie Greifzange, 300 mm, drehbar, <i>Biopsy forceps, 300 mm, rotatable,</i>	Ø 0,9 mm
	<b>60-7060</b>	Greifzange, 300 mm, drehbar, <i>Grasping forceps, 300 mm, rotatable,</i>	Ø 0,9 mm
	<b>60-7065</b>	Greifzange, 1 x 2 Zähne, 300 mm, drehbar, <i>Rat tooth forceps, 1 x 2 teeth, 300 mm, rotatable,</i>	Ø 0,9 mm
	<b>60-7070</b>	Schere, 300 mm, drehbar, <i>Scissors, 300 mm, rotatable,</i>	Ø 0,9 mm

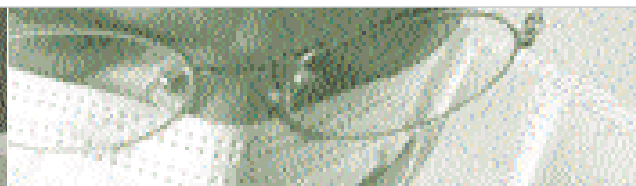





## MINI NEURO SET | *MINI NEURO SET*

### MONOPOLARE ELEKTRODEN | *MONOPOLAR ELECTRODES*

Für den Einsatz mit 302 mm Endoskopen 60-7100, 60-7105 und 60-7110 | *For use with 302 mm endoscopes 60-7100, 60-7105 and 60-7110*



	<b>60-7075</b>	Hakenelektrode, vollständig isoliert, 300 mm, <i>Hook electrode, fully insulated, 300 mm,</i>	2,1 mm
	<b>60-7080</b>	Knopfelektrode, vollständig isoliert, 300 mm, <i>Button electrode, fully insulated, 300 mm,</i>	1,2 mm
	<b>60-7084</b>	J-Hakenelektrode, vollständig isoliert, 300 mm, <i>J hook electrode, fully insulated, 300 mm,</i>	2,1 mm
	<b>60-7085</b>	Nadelelektrode, vollständig isoliert, 300 mm, <i>Needle electrode, fully insulated, 300 mm,</i>	1,2 mm
	<b>60-7087-750</b>	Monopolar Nadelelektrode für Neuroendoskopie, 750 mm, <i>Monopolar needle electrode for neuroendoscopy, 750 mm,</i>	0,7 mm
	<b>60-7088-750</b>	Monopolar L-Elektrode für Neuroendoskopie, 750 mm, <i>Monopolar L electrode for neuroendoscopy, 750 mm,</i>	0,7 mm





# MINI NEURO SET | MINI NEURO SET

## MONOPOLARE ELEKTRODEN | MONOPOLAR ELECTRODES

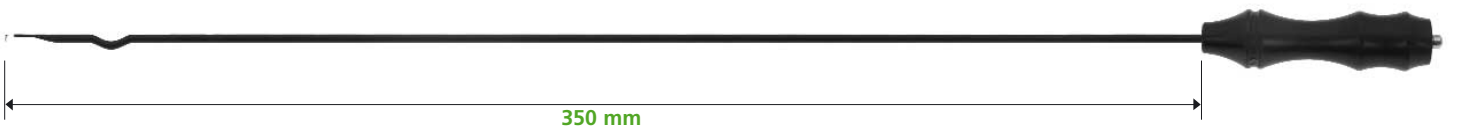
Für den Einsatz mit 302 mm Endoskopen 60-7100, 60-7105 und 60-7110 | For use with 302 mm endoscopes 60-7100, 60-7105 and 60-7110



	<b>60-7075-350</b>	Hakenelektrode, vollständig isoliert, <i>Hook electrode, fully insulated,</i>	2,1 mm
	<b>60-7076-350</b>	„J“ Hakenelektrode, vollständig isoliert, <i>„J“ hook electrode, fully insulated,</i>	2,1 mm
	<b>60-7080-350</b>	Knopfelektrode, vollständig isoliert, <i>Button electrode, fully insulated,</i>	1,2 mm
	<b>60-7085-350</b>	Nadelelektrode, vollständig isoliert, <i>Needle electrode, fully insulated,</i>	1,2 mm

## BIPOLEARE ELEKTRODEN | BIPOLAR ELECTRODES

Für den Einsatz mit 302 mm Endoskopen 60-7100, 60-7105 und 60-7110 | For use with 302 mm endoscopes 60-7100, 60-7105 and 60-7110



	<b>60-7086</b>	Bipolare Gabelelektrode für Neuroendoskopie, 350 mm, <i>Bipolar fork electrode for neuroendoscopy, 350 mm,</i>	2,1 mm
---	----------------	---	--------

60

ACKERMANN INSTRUMENTE GmbH, GERMANY  
Eisenbahnstraße 65-67  
78604 Rietheim-Weilheim

Phone: ++49 (0) 74 61 / 9 66 17-0  
Fax: ++49 (0) 74 61 / 9 66 17-70

[info@ackermanninstrumente.de](mailto:info@ackermanninstrumente.de)  
[www.ackermanninstrumente.de](http://www.ackermanninstrumente.de)