

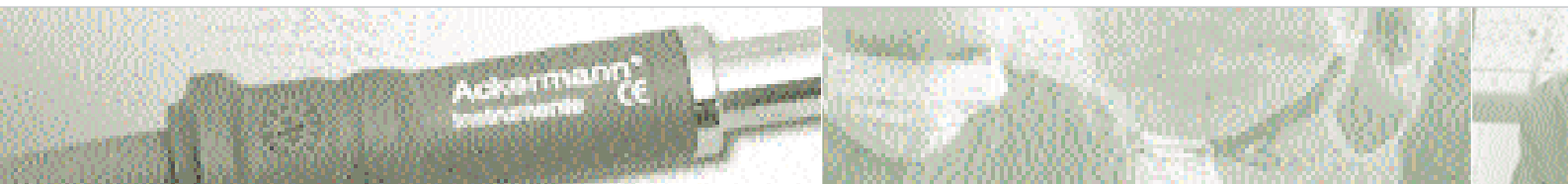

ENDOSKOPE, ELEKTRODEN, SAUG-SPÜLELEMENTE
ENDOSCOPES, ELECTRODES, SUCTION IRRIGATION SYSTEMS

11



OPTIKEN | SCOPES

EAGLE VISION AUTOKLAVIERBARE ENDOSKOPE | EAGLE VISION AUTOCLAVABLE SCOPES

Direktverriegelung mit Adapter 15-1702 DC
 Direct Coupling with adapter 15-1702 DC

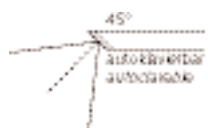
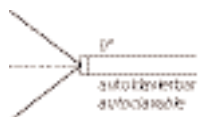

11-1120-4	Laparoskop, autoklavierbar, Hochleistungslinse, <i>Laparoscope, fully autoclavable, high performance lens,</i>	4 mm 0°
11-1120	Laparoskop, autoklavierbar, Hochleistungslinse, <i>Laparoscope, fully autoclavable, high performance lens,</i>	5 mm 0°
11-1120G	Laparoskop, autoklavierbar, Hochleistungslinse, Gold Version, <i>Laparoscope, fully autoclavable, high performance lens, gold version,</i>	5 mm 0°
11-1125	Laparoskop, autoklavierbar, Hochleistungslinse, <i>Laparoscope, fully autoclavable, high performance lens,</i>	5 mm 30°
11-1125G	Laparoskop, autoklavierbar, Hochleistungslinse, Gold Version, <i>Laparoscope, fully autoclavable, high performance lens, gold version,</i>	5 mm 30°
11-1126	Laparoskop, autoklavierbar, Hochleistungslinse, <i>Laparoscope, fully autoclavable, high performance lens,</i>	5 mm 45°
11-1126G	Laparoskop, autoklavierbar, Hochleistungslinse, Gold Version, <i>Laparoscope, fully autoclavable, high performance lens, gold version,</i>	5 mm 45°



OPTIKEN | SCOPES

EAGLE VISION AUTOKLAVIERBARE ENDOSKOPE | EAGLE VISION AUTOCLAVABLE SCOPES



11

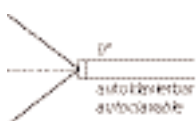

11-1130	Laparoskop, autoklavierbar, Hochleistungslinse, <i>Laparoscope, fully autoclavable, high performance lens,</i>	10 mm 0°
11-1130-180	Laparoskop, autoklavierbar, Hochleistungslinse, 180 mm, <i>Laparoscope, fully autoclavable, high performance lens, 180 mm,</i>	10 mm 0°
11-1130G	Laparoskop, autoklavierbar, Hochleistungslinse, Gold Version, <i>Laparoscope, fully autoclavable, high performance lens, gold version,</i>	10 mm 0°



11-1135	Laparoskop, autoklavierbar, Hochleistungslinse, <i>Laparoscope, fully autoclavable, high performance lens,</i>	10 mm 30°
11-1135-180	Laparoskop, autoklavierbar, Hochleistungslinse, 180 mm, <i>Laparoscope, fully autoclavable, high performance lens, 180 mm,</i>	10 mm 30°
11-1135G	Laparoskop, autoklavierbar, Hochleistungslinse, Gold Version, <i>Laparoscope, fully autoclavable, high performance lens, gold version,</i>	10 mm 30°



11-1136	Laparoskop, autoklavierbar, Hochleistungslinse, <i>Laparoscope, fully autoclavable, high performance lens,</i>	10 mm 45°
11-1136G	Laparoskop, autoklavierbar, Hochleistungslinse, Gold Version, <i>Laparoscope, fully autoclavable, high performance lens, gold version,</i>	10 mm 45°



11-1137	Laparoskop, autoklavierbar, Hochleistungslinse,* <i>Laparoscope, fully autoclavable, high performance lens,*</i>	6,5 mm 30°
----------------	---	---------------

* für Doppelstich-Sterilisation | *for sterilisation double puncture*

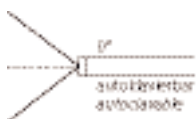

11-1138	Laparoskop, autoklavierbar, 100000 Pix, Fiberskop <i>Laparoscope, fully autoclavable, 100.000 pix, fiberscope</i>	5,0 mm 0°
----------------	--	--------------

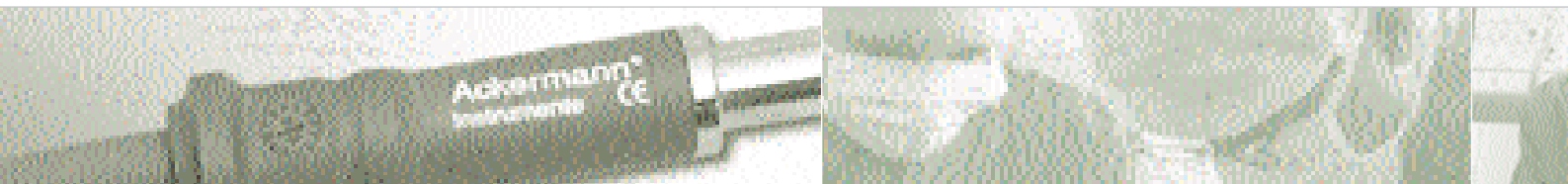

OPTIKEN | SCOPES

OPERATIONS LAPAROSKOPE | OPERATING LAPAROSCOPES

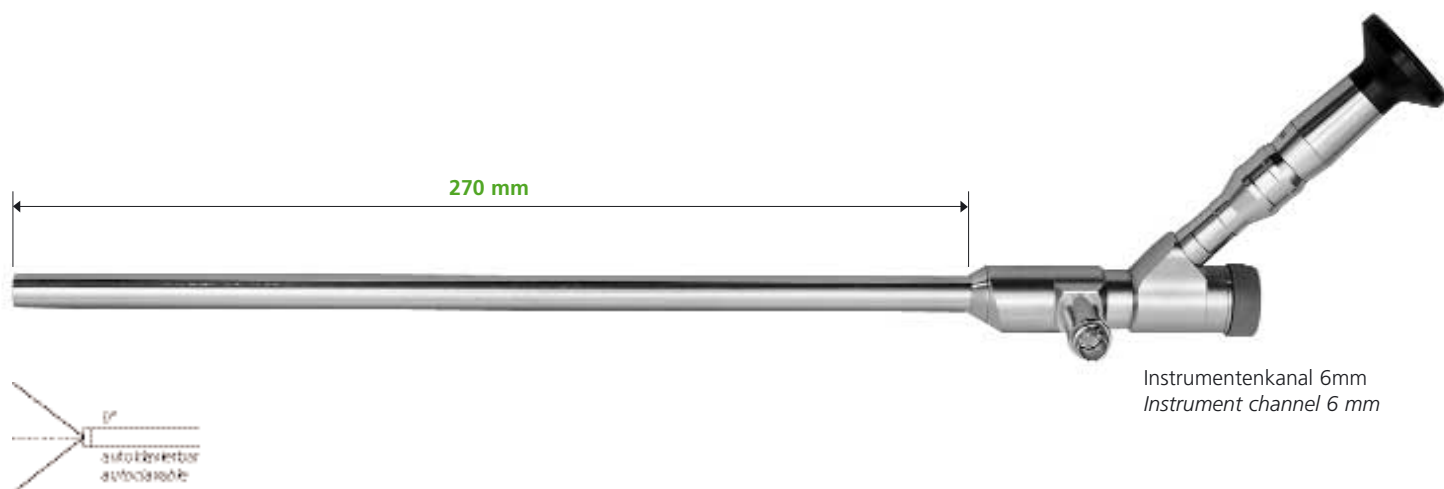

Instrumentenkanal 6mm
Instrument channel 6 mm



10-1140	Operations-Laparoskop mit 45° Ansicht, <i>Operating Laparoscope with 45° view,</i>	10 mm 0°
10-1140G	Operations-Laparoskop mit 45° Ansicht, Gold Version, <i>Operating Laparoscope with 45° view, gold version,</i>	10 mm 0°



10-1145	Operations-Laparoskop mit 90° Ansicht, <i>Operating Laparoscope with 90° view,</i>	10 mm 0°
10-1145G	Operations-Laparoskop mit 90° Ansicht, Gold Version, <i>Operating Laparoscope with 90° view, gold version,</i>	10 mm 0°



ADAPTER FÜR LICHTLEITKABEL | ADAPTERS FOR LIGHT GUIDES

LICHTQUELLEN-SEITE
LIGHTSOURCE-SIDE

ENDOSKOP-SEITE
ENDOSCOPE-SIDE



11-1147-100 Ackermann® / Storz®
Ackermann® / Storz®



11-1146-100

11-1147-100HS Ackermann® / Storz® mit Hitzeschutz*
Ackermann® / Storz® with heat shield*



11-1147-200 Wolf
Wolf



11-1146-200

11-1147-200HS Wolf mit Hitzeschutz*
Wolf with heat shield*



11-1147-300 ACM / Circon
ACM / Circon

11-1146-300

11-1147-300HS ACM / Circon mit Hitzeschutz*
ACM / Circon with heat shield*



11-1147-400 Olympus
Olympus

11-1147-400HS Olympus mit Hitzeschutz*
Olympus with heat shield*

11-1147-400OLY Olympus Lichtquellen Booster
Olympus light source booster



11-1147-500 Pentax
Pentax

11-1147-500HS Pentax mit Hitzeschutz*
Pentax with heat shield*



11-1147-800 Stryker
Stryker

11-1147-800HS Stryker mit Hitzeschutz*
Stryker with heat shield*

* für 300W und 600W Xenon | for 300W and 600W Xenon



10-16000CB Lichtkabel Tester,
Power meter for fibers Ackermann®
Storz®

10-16000CBOLY Lichtkabel Tester,
Power meter for fibers Olympus®

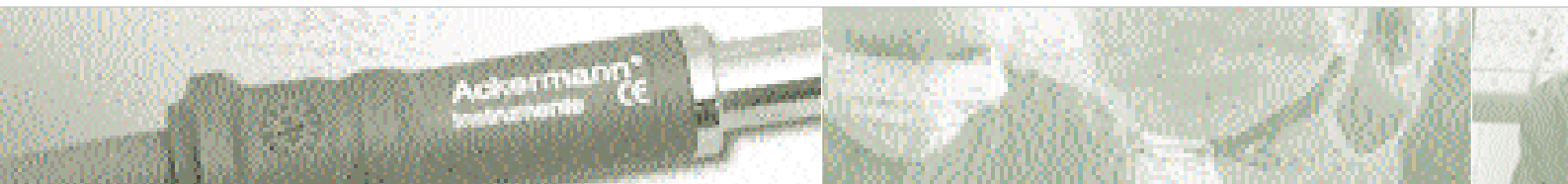

LICHTLEITKABEL | LIGHT GUIDES



Hochverdichtetes Ackermann-Kabel
High compressed Ackermann cable



30 % mehr Licht
30 % more light

Standard-Kabel des Wettbewerbs
Conventional cable of competitors



Weniger Licht durch Hohlräume
Less light due to spaces

11-1148	Hochleistungslichtleiter, hitzegeschützt für 300 W und 600 W Xenon Lichtquellen (SH Modell), <i>High performance light cable, heat shielded for 300 and 600 W Xenon bulbs (SH model),</i>	6,0 mm x 2,3 m
11-1149	Hochleistungslichtleiter, hitzegeschützt für 300 W und 600 W Xenon Lichtquellen (SH Modell), <i>High performance light cable, heat shielded for 300 and 600 W Xenon bulbs (SH model),</i>	6,0 mm x 3,0 m
11-1150	Hochleistungslichtleiter, PF Performance, <i>High performance light cable, PF Performance,</i>	3,5 mm x 1,8 m
11-1151	Hochleistungslichtleiter, PF Performance, <i>High performance light cable, PF Performance,</i>	3,5 mm x 2,3 m
11-1152	Hochleistungslichtleiter, PF Performance, <i>High performance light cable, PF Performance,</i>	3,5 mm x 3,0 m
11-1159	Fiber Lichtleiter, Standard, <i>Fibre light cable, standard,</i>	4,8 mm x 2,3 m
11-1160	Fiber Lichtleiter, Standard, <i>Fibre light cable, standard,</i>	4,8 mm x 1,8 m
11-1161	Hochleistungs-Lichtleiter, hitzegeschützt für 300 W und 600 W Xenon Lichtquellen (SH Modell), <i>High performance light cable, heat shielded for 300 and 600 W Xenon bulbs (SH model),</i>	4,8 mm x 3,0 m



LICHTLEITKABEL | LIGHT GUIDES



Hochverdichtetes Ackermann-Kabel
High compressed Ackermann cable



30 % mehr Licht
30 % more light

Standard-Kabel des Wettbewerbs
Conventional cable of competitors



Weniger Licht durch Hohlräume
Less light due to spaces

11-1162	Hochflexibler Lichtleiter, Standard, <i>Superflexible light cable, standard,</i>	3,5 mm x 2,3 m
11-1163	Hochflexibler Lichtleiter, Standard, <i>Superflexible light cable, standard,</i>	3,5 mm x 1,8 m
11-1164	Flüssiglichtleitkabel , neue Flüssigkeit, mehr Licht, <i>Fluid light cable, new fluid - more light,</i>	5,0 mm x 2,3 m
11-1165	Flüssiglichtleitkabel , neue Flüssigkeit, mehr Licht, <i>Fluid light cable, new fluid - more light,</i>	5,0 mm x 1,8 m
11-1166	Hochflexibler Lichtleiter, Standard, <i>Superflexible light cable, standard,</i>	3,5 mm x 3,0 m
11-1167	Hochleistungslichtleiter, hitzegeschützt für 300 W und 600 W Xenon Lichtquellen (SH Modell), <i>High performance light cable, heat shielded for 300 and 600 W Xenon bulbs (SH Model),</i>	4,8 mm x 2,3 m
11-1168	Hochleistungslichtleiter, hitzegeschützt für 300 W und 600 W Xenon Lichtquellen (SH Modell), <i>High performance light cable, heat shielded for 300 and 600 W Xenon bulbs (SH Model),</i>	4,8 mm x 1,8 m
11-1169	Fiber Lichtleiter, Standard, <i>Fibre light cable, standard,</i>	4,8 mm x 3,0 m

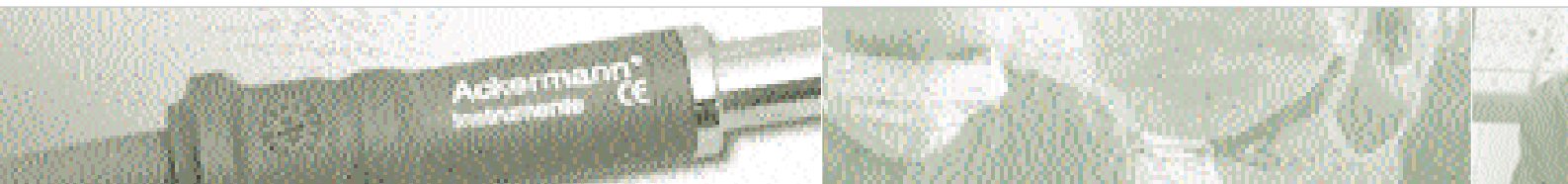

ELEKTRODEN | CAUTERIES



11-1170	Elektrode, Spatelspitze, HF, Cauteries, spatula tip, HF-port,	330 mm Arbeitslänge working length
11-1175	Elektrode, L-Haken-Spitze, HF, Cauteries, L-hook tip, HF-port,	330 mm Arbeitslänge working length
11-1180	Elektrode, Messerspitze, HF, Cauteries, knife tip, HF-port,	330 mm Arbeitslänge working length
11-1185	Elektrode, J-Hakenspitze, HF, Cauteries, J-hook tip, HF-port,	330 mm Arbeitslänge working length
11-1188	Sichel-Elektrode, 5 mm, adaptierbar Sichel electrode, 5 mm, adaptable	330 mm Arbeitslänge working length
11-1195	Elektrode, Saug-Spitze, HF, Cauteries, suction coagulation tip, HF-port,	330 mm Arbeitslänge working length
11-1200	Elektrode, Nadel-Spitze, HF, Cauteries, needle tip, HF-port,	330 mm Arbeitslänge working length
11-1205	Elektrode, Konus-Spitze, HF, Cauteries, cone tip, HF-port,	330 mm Arbeitslänge working length
11-1210	Elektrode, Knopf-Spitze, HF, Cauteries, button tip, HF-port,	330 mm Arbeitslänge working length



ELEKTRODEN | CAUTERIES

11

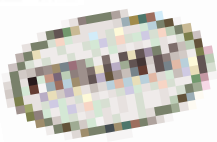

11-1170C	Elektrode, Spatelspitze, mit Keramik Spitze, Cauteries, spatula tip, with ceramic tip,	330 mm Arbeitslänge working length
11-1175C	Elektrode, L-Haken-Spitze, mit Keramik Spitze, Cauteries, L-hook tip, with ceramic tip,	330 mm Arbeitslänge working length
11-1185C	Elektrode, J-Hakenspitze, mit Keramik Spitze, Cauteries, J-hook tip, with ceramic tip,	330 mm Arbeitslänge working length



11-1178	Spatel Elektrode, adaptierbar Spatula electrode, adaptable	330 mm Arbeitslänge working length
11-1179	L-Haken Elektrode, adaptierbar L Hook electrode, adaptable	330 mm Arbeitslänge working length
11-1181	Messer Elektrode, adaptierbar Knife electrode, adaptable	330 mm Arbeitslänge working length
11-1182	J-Haken Elektrode, adaptierbar J-hook-electrode, adaptable	330 mm Arbeitslänge working length
11-1183	Elektrode, adaptierbar Electrode, adaptable	330 mm Arbeitslänge working length
11-1184	Knopf Elektrode, adaptierbar Button electrode, adaptable	330 mm Arbeitslänge working length
11-1186	Konus Elektrode, adaptierbar Cone electrode, adaptable	330 mm Arbeitslänge working length
11-1187	Nadel-Elektrode, 5 mm, adaptierbar Needle electrode, 5 mm, adaptable	330 mm Arbeitslänge working length

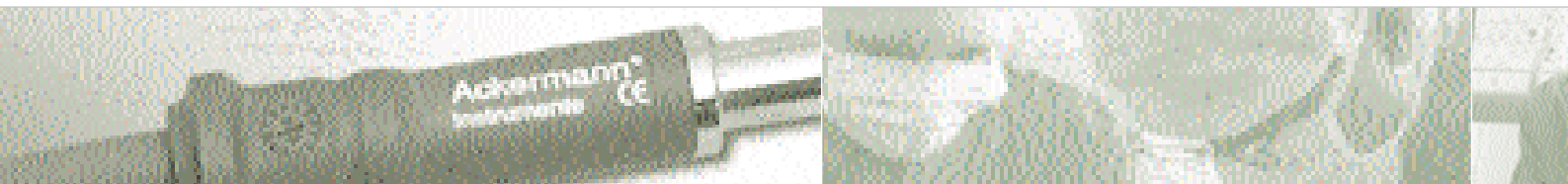

SAUG-SPÜLELEMENTE | SUCTION-IRRIGATION SYSTEMS



11-1171

Trompetenventil für adaptierbare Elektroden
Trumpet valve for adaptable electrodes



11-1172

Ventilkörper für adaptierbare Elektroden
Valve body for adaptable electrodes



11-1173

2 Wege Ventil für adaptierbare Elektroden
Two way valve for adaptable electrodes



11-1174

Pistolengriff für adaptierbare Elektroden
Pistol-handle for adaptable electrodes



11-1176

Trompetenventil für adaptierbare Elektroden
Trumpet valve for adaptable electrodes



11-1177

Trompetenventil für adaptierbare Elektroden
Trumpet valve for adaptable electrodes



BIPOLARE ELEKTRODEN | *BIPOLAR ELECTRODES*



11



11-1190	Bipolare Schneide-Elektrode <i>Bipolar cut electrodes</i>
11-1191	Bipolare L-Haken Elektrode <i>Bipolar L-hook electrode</i>
11-1192	Bipolare Ball-Elektrode <i>Bipolar ball electrode</i>
11-1193	Bipolare J-Haken Elektrode <i>Bipolar J-hook electrode</i>
11-1194	Bipolare Nadel-Elektrode <i>Bipolar needle electrode</i>

PASSENDE KABEL | *SUITABLE CABLES*



13-1641	Bipolares Kabel für US-Generatoren <i>Bipolar cable for US-Generators</i>
----------------	--

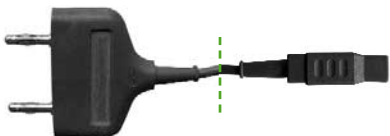

13-1641VA	Bipolares Kabel für US-Generatoren einschließlich Adapter <i>Bipolar cable for US-Generators with included adapter</i>
------------------	---



13-1643	Bipolares Kabel für ERBE-Generatoren <i>Bipolar cable for ERBE Generators</i>
----------------	--



13-1644	Bipolares Kabel für Martin / Berchtold Generatoren <i>Bipolar cable for Martin / Berchtold Generators</i>
----------------	--

SAUG-SPÜLELEMENTE | SUCTION-IRRIGATION SYSTEMS



ARBEITSLÄNGE | WORKING LENGTH

330 MM

450 MM



330 MM	450 MM	
11-1215	11-1215-45	Elektroden, Spatel-Spitze, HF-Saug-Kanal Cauteries, spatula tip, HF-port, suction channel
11-1220	11-1220-45	Elektrode, L-Haken-Spitze, HF-Saug-Kanal, Cauteries, L-hook tip, HF-port, suction channel,
11-1225	11-1225-45	Elektrode, Messerspitze, HF-Saug-Kanal Cauteries, knife tip, HF-port, suction channel
11-1230	11-1230-45	Elektrode, J-Hakenspitze, HF-Saug-Kanal Cauteries, J-hook tip, HF-port, suction channel
11-1240	11-1240-45	Elektrode, Saug-Spitze, HF-Saug-Kanal Cauteries, suction coagulation tip, HF-port, suction channel
11-1245	11-1245-45	Elektrode, Nadel-Spitze, HF-Saug-Kanal Cauteries, needle tip, HF-port, suction channel
11-1250	11-1250-45	Elektrode, Konus-Spitze, HF-Saug-Kanal Cauteries, cone tip, HF-port, suction channel
11-1255	11-1255-45	Elektrode, Knopf-Spitze, HF-Saug-Kanal Cauteries, button tip, HF-port, suction channel

ZUBEHÖR | ACCESSORIES

11-1230-100	Ventilersatzteil Abdeckkappe mit Bohrung Valvesparepart top screw with hole
11-1230-101	Ventilersatzteil Abdeckkappe ohne Bohrung Valve sparepart bottom screw without hole
11-1230-102	Ventilersatzteil Drücker Valve sparepart plunger
11-1230-103	Ventilersatzteil Feder Valve sparepart spring



CHOLANGIOGRAM INSTRUMENTE | CHOLANGIOGRAM INSTRUMENTS



11

11-1249 Cholangiogram Zange, Ø 5 mm, mit Sperre, *Cholangiogram forceps, Ø 5 mm, with ratchet,* 330 mm
Arbeitslänge | *working length*



11-1680 Leitkanüle für Katheter, 360 mm
Guide tube for catheter, 360 mm



11-1681 Leithaken für Katheter, 5 mm
Guide hook for catheter, 5 mm

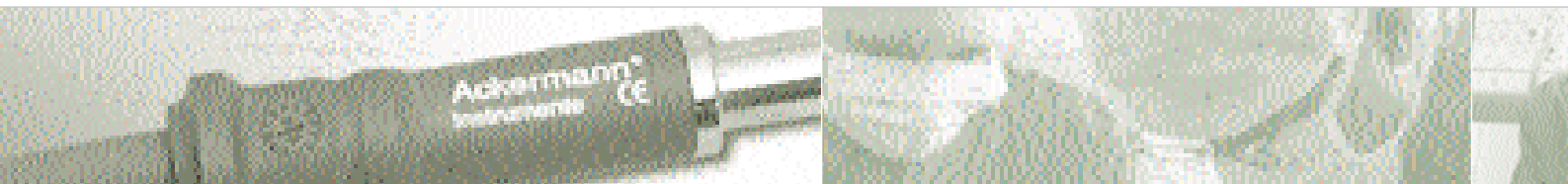

MONOPOLARE KABEL | *MONOPOLAR CABLES*



Ø 4 mm

10-1260

HF-Kabel für alle Ackermann Instrumente, monopolarer Gebrauch, Geräteanschluss 4 mm
HF-cable to all Ackermann Instruments, monopolar use, generatorside

10-1260-3

HF-Kabel für alle Ackermann Instrumente, monopolarer Gebrauch, 3 Meter
HF-cable to all Ackermann Instruments, monopolar use, 3 meters



Ø 5 mm

11-1261

HF-Kabel für alle Ackermann Instrumente, monopolarer Gebrauch, Geräteanschluss 5 mm
HF-cable to all Ackermann Instruments, monopolar use, generatorside



Ø 8 mm

11-1262

HF-Kabel für alle Ackermann Instrumente, monopolarer Gebrauch, Geräteanschluss 8 mm Bovie
HF-cable to all Ackermann Instruments, monopolar use, generatorside



11-1260UR

HF-Kabel für Urologie, und monopolaren Gebrauch, Geräteanschluss 4 mm
HF-cable for Urology, and monopolar use, generatorside

11-1261UR

HF-Kabel für Urologie, und monopolaren Gebrauch, Geräteanschluss 5 mm
HF-cable for Urology, and monopolar use, generatorside

11-1262UR

HF-Kabel für alle Ackermann Instrumente, monopolarer Gebrauch, Geräteanschluss* 8 mm Bovie
*HF-cable to all Ackermann Instruments, monopolar use, generatorside**

* Urologie | *Urology*



SAUG-SPÜLELEMENTE | SUCTION-IRRIGATION SYSTEMS



11-1235	Saug-Spül-System mit Trompetenventilen Suction irrigation system with trumpet valves	11
11-1235-100	5 mm Rohr für 11-1235 5 mm tubes for 11-1235	
11-1235-101	10 mm Rohr für 11-1235 10 mm tubes for 11-1235	
11-1235-102	Ventilgrundkörper ohne Rohre Valve body without tubes	



SAUG-SPÜLELEMENTE | SUCTION-IRRIGATION SYSTEMS

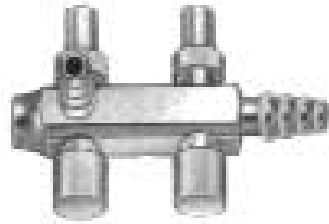

SCHÄFTE BITTE GESONDERT BESTELLEN | PLEASE ORDER SHEATHS SEPARATE

11-1236

Modularer Saugspülgriff für 5 mm und 10 mm Rohre
Modular suction and irrigation handle for 5 mm and 10 mm sheaths

11-1236COM

Modularer Saugspülgriff für 5 mm und 10 mm Rohre, einschl. **11-1237** und **11-1238**
Mod. suction and irrigation handle for 5 and 10 mm sheaths, incl. **11-1237** and **11-1238**



11-1237-3

3 mm Schaft,
3 mm sheath,

für | for
11-1236

11-1237-700

3 mm Schaft, mit 12 Bohrungen,
3 mm sheath, with 12 holes

für | for
11-1236

11-1237

5 mm Schaft,
5 mm sheath,

für | for
11-1236

11-1237-100

5 mm Schaft mit vielen Bohrungen,
5 mm sheath with excessive holes,

für | for
11-1236

11-1237-200

5 mm Schaft mit vielen Bohrungen, Spitze eingezogen,
5 mm sheath with excessive holes tip rounded off,

für | for
11-1236

11-1237-300

5 mm Schaft mit vielen Bohrungen, Spitze stark eingezogen,
5 mm sheath with excessive holes tip strongly rounded off,

für | for
11-1236

11-1237-400

5 mm Schaft, Nadel-Form,
5 mm sheath, needle form,

für | for
11-1236

11-1237-500

5 mm Schaft, Micro Spitze,
5 mm sheath, micro tip,

für | for
11-1236

11-1237-600

5 mm Schaft, verjüngte Spitze,
5 mm sheath, tapered tip,

für | for
11-1236

11-1237-800

5 mm Schaft,
5 mm sheath,

für | for
11-1236



11-1238

10 mm Schaft,
10 mm sheath,

für | for
11-1236



SAUG-SPÜLELEMENTE | SUCTION-IRRIGATION SYSTEMS



11

11-1236D

Modularer Saugspülgriff für 5 mm und 10 mm Rohre, einmalverwendbar mit Schlauchset
Modular suction and irrigation handle for 5 mm and 10 mm sheaths with tubing set



11-1237D

5 mm Schaft, mehrfachverwendbar,
5 mm sheath, resposable,

für | for
11-1236D

11-1238D

10 mm Schaft, mehrfachverwendbar,
10 mm sheath, resposable,

für | for
11-1236D



11-1275D

2 Weg Saug-Spül-System mit Trompetenventilen einmalverwendbar mit Schlauchset
Two-way suction and irrigating system with trumpet valves, disposable with tube set

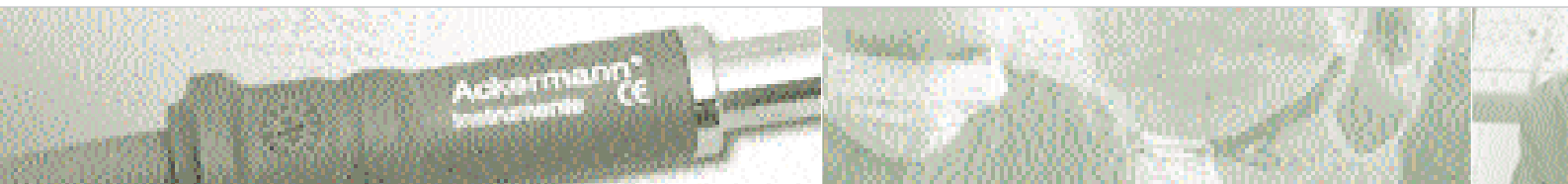

SAUG-SPÜLEMENTE | SUCTION-IRRIGATION SYSTEMS

11-1266

Saug-Spül-System für Austauschschaft
Suction irrigation system for exchangeable sheath



11-1267

Saug-Spül-System für Austauschschaft
Suction irrigation system for exchangeable sheath



11-1268

Saug-Spül-System für Austauschschaft-Pistolen-Griff
Suction irrigation system for exchangeable sheath, pistol handle



11-1271

Adaptierbare Saugschäfte
Adaptable suction sheaths

5 mm



11-1272

Adaptierbare Saugschäfte
Adaptable suction sheaths

10 mm





SAUG-SPÜLELEMENTE | SUCTION-IRRIGATION SYSTEMS



11

11-1269	Zwei-Wege-Ventil adaptierbar <i>Two way valve adaptable</i>	
11-1271L	Schäfte, <i>Sheaths,</i>	5 mm
11-1272L	Schäfte, <i>Sheaths,</i>	10 mm



11-1270	Saugkanüle mit Hahn, <i>Suction tube with stopcock,</i>	5 mm x 330 mm
11-1270-3	Saugkanüle mit Hahn, <i>Suction tube with stopcock,</i>	3 mm x 330 mm
11-1270-45	Saugkanüle mit Hahn, <i>Suction tube with stopcock,</i>	5 mm x 450 mm

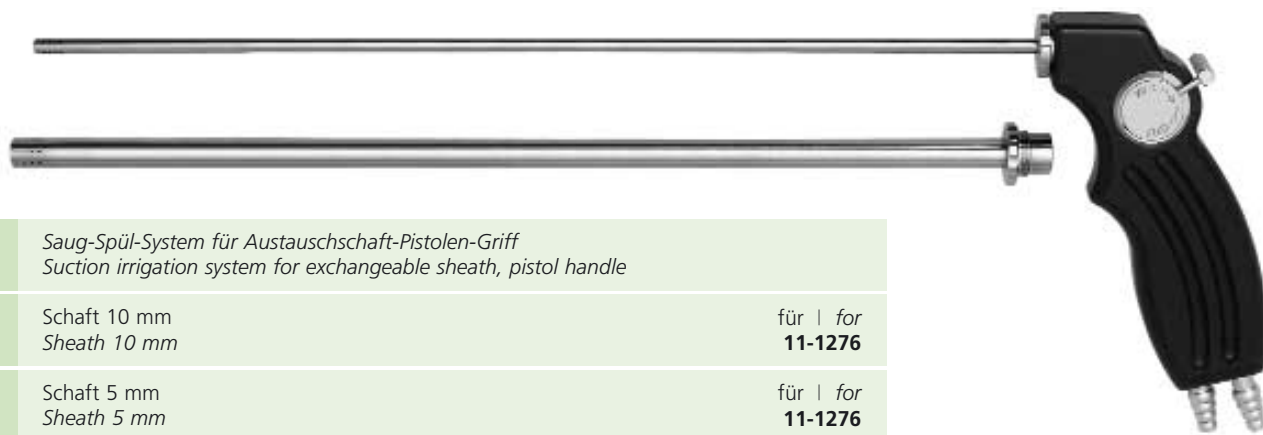

11-1276	Saug-Spül-System für Austauschschacht-Pistolen-Griff <i>Suction irrigation system for exchangeable sheath, pistol handle</i>	
11-1277	Schaft 10 mm <i>Sheath 10 mm</i>	für for 11-1276
11-1278	Schaft 5 mm <i>Sheath 5 mm</i>	für for 11-1276

11-1279	Elektrodenadapter <i>Electrode-adaptor</i>	für for 11-1276
----------------	---	-----------------------------



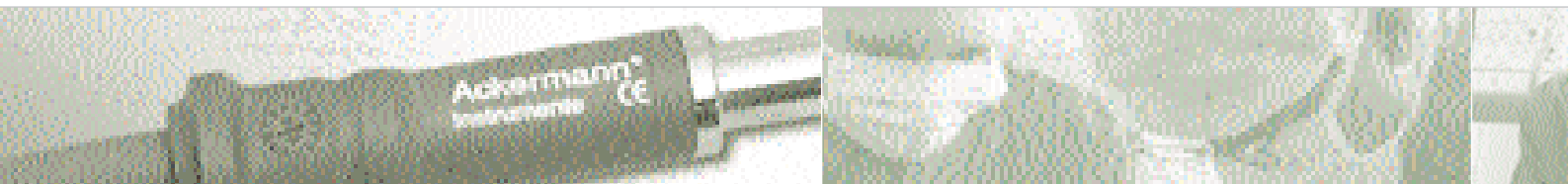

SAUG-SPÜLELEMENTE | SUCTION-IRRIGATION SYSTEMS



11-1275

2 Weg Saug-Spül-System mit Trompetenventilen
Two-way suction and irrigating system with trumpet valves

11-1275-3

2 Weg Saug-Spül-System mit Trompetenventilen,
Two-way suction and irrigating system with trumpet valves,

3 mm Version
3 mm version



11-1265

Absaugkanüle für Laserfaser
Irrigating aspirating cannula, channel for laser fibre



11-1251

Gallenblasenextractor
Gall bladder extractor

ACKERMANN INSTRUMENTE GmbH, GERMANY
Eisenbahnstraße 65-67
78604 Rietheim-Weilheim

Phone: ++49 (0) 74 61 / 9 66 17-0
Fax: ++49 (0) 74 61 / 9 66 17-70

info@ackermanninstrumente.de
www.ackermanninstrumente.de